

SMD ▪ HP

EAHP3030WA1



Features

- Top view white LED
- High luminous intensity output
- Typical Viewing Angle:120°
- Pb-free
- RoHS compliant

Description

The Everlight Americas EAHP3030WA1 package has high efficacy, high CRI, mid power consumption, wide viewing angle and a compact form factor. These features make this package an ideal LED for all lighting applications.

Applications

- General lighting
- Decorative and Entertainment Lighting
- Indicators
- Illumination

Absolute Maximum Ratings

Parameter	Symbol	Ratings	Unit
Max. DC Forward Current (mA)	I_F	240	mA
Max. Peak Pulse Current (mA)	I_{Pulse}	300 _[1]	mA
Power Dissipation	P_d	1	W
Thermal Resistance	R_{th}	15	°C/W
Max. Junction Temperature	T_J	115	°C
Operating Temperature	T_{Opr}	-40 ~ +85	°C
Storage Temperature	T_{Stg}	-40 ~ +100	°C
Max. Soldering Temperature	T_{Sol}	260	°C
Max. Allowable Reflow Cycles	n/a	2	cycles

Notes: Duty cycle = 1/10@1KHZ

Electro-Optical Characteristics

Order Code	Minimum Luminous Flux (lm)	Typical Luminous Flux (lm)	CCT (K) Wavelength (nm)	Forward Voltage (V)	Current (mA)	CRI (Min.)
EAHP3030WA1	95	106	2870-3220K	5.8~7.0	150	80

Notes:

1. Luminous flux measurement tolerance: $\pm 10\%$.
2. The data of luminous flux measured at thermal pad=25
3. Typical luminous flux or light output performance is operated within the condition guided by this datasheet.
4. The CRI value is based on the Everlight Americas testing instrument.
5. CRI measurement tolerance: ± 2 .



Luminous Flux Bins of Product Binning

Group	Bin	Minimum Photometric Flux (lm)	Maximum Photometric Flux (lm)
R	1	50.0	55.0
	2	55.0	60.0
	3	60.0	65.0
	4	65.0	70.0
	5	70.0	76.0
	6	76.0	83.0
	7	83.0	90.0
8	1	90.0	95.0
	2	95.0	100.0

Group	Bin	Minimum Photometric Flux (lm)	Maximum Photometric Flux (lm)
S	1	100.0	110.0
	2	110.0	120.0
	3	120.0	130.0
	4	130.0	140.0
	5	140.0	150.0
	6	150.0	160.0
	7	160.0	170.0
	8	170.0	180.0
--	--	--	--

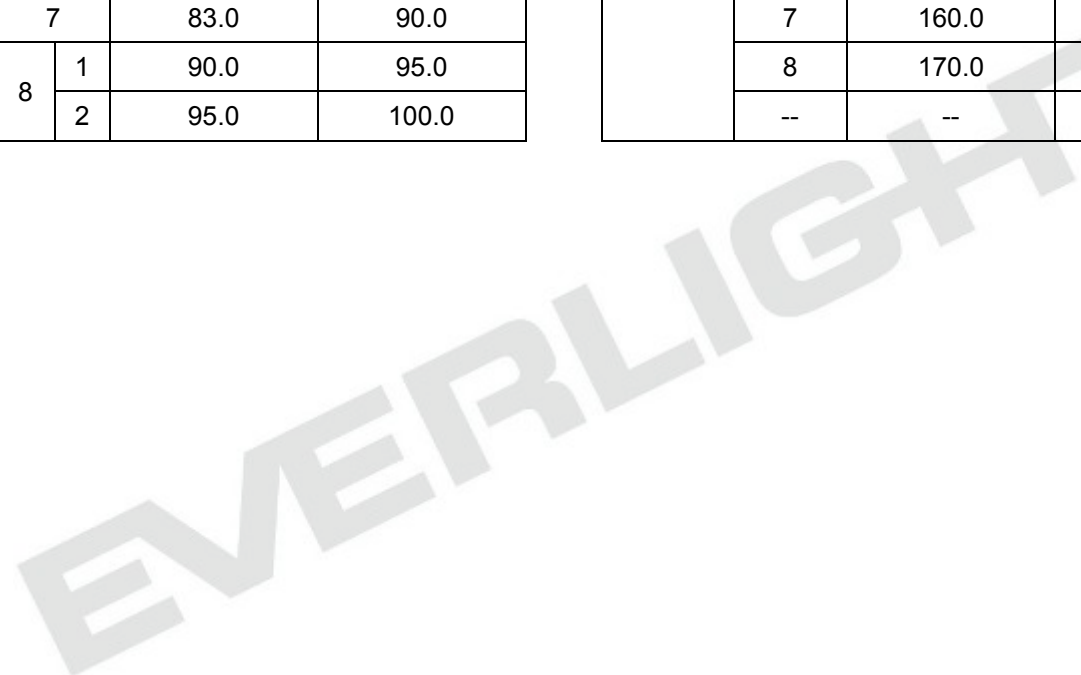

White Bin Structure

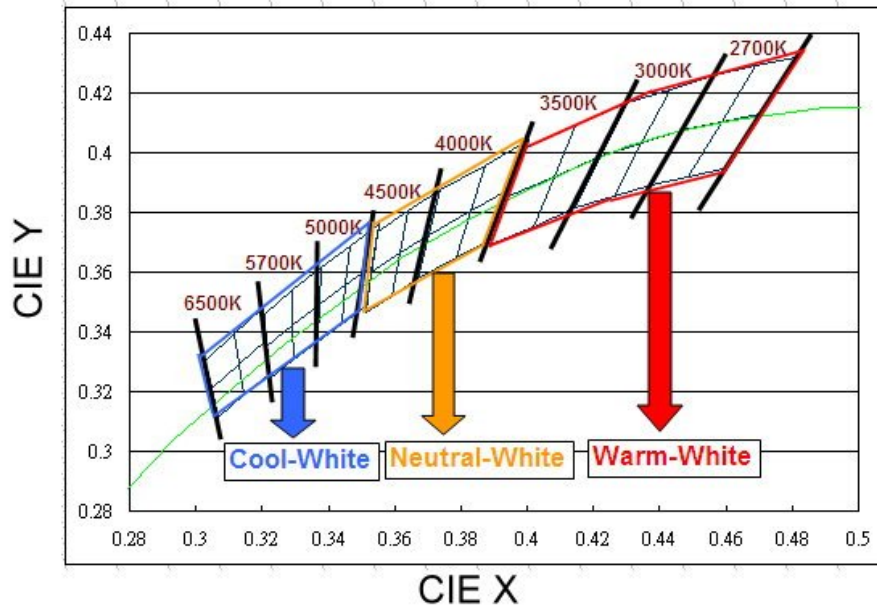

Chromaticity specification defined by ANSI

Notes:

1. The CCT range of Cool-White varies from 4745K to 7050K.
2. The CCT range of Neutral-White varies from 3710K to 4745K.
3. The CCT range of Warm-White varies from 2580K to 3710K
4. Color coordinates measurement allowance : ± 0.01
5. Color bins are defined at $I_f=150\text{mA}$ operation

Warm-White Bin Structure

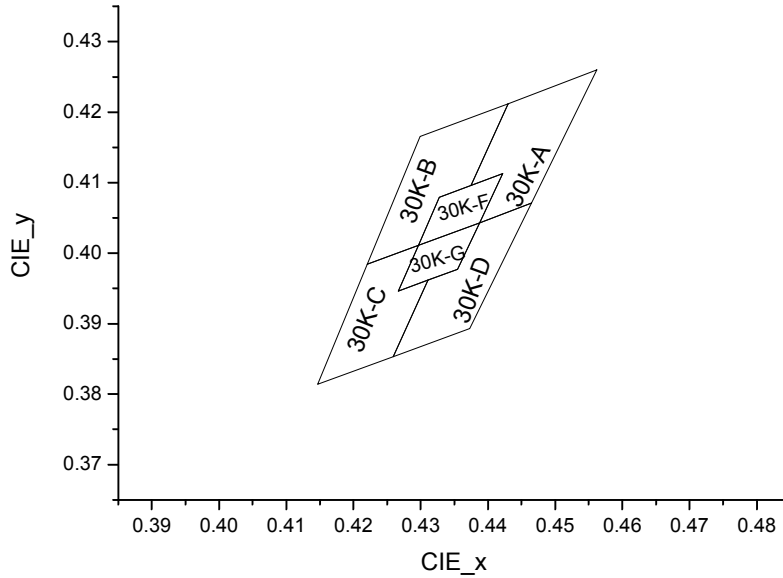

Warm-White Bin Coordinates

3000K

Bin	CIE X	CIE Y
30K-A	0.4562	0.4260
	0.4430	0.4212
	0.4375	0.4096
	0.4422	0.4113
	0.4388	0.4043
	0.4465	0.4071
Reference Range: 2870~3000K		

Bin	CIE X	CIE Y
30K-B	0.4430	0.4212
	0.4299	0.4165
	0.4221	0.3984
	0.4297	0.4011
	0.4328	0.4079
	0.4375	0.4096
Reference Range: 3000~3220K		

Bin	CIE X	CIE Y
30K-C	0.4221	0.3984
	0.4147	0.3814
	0.4259	0.3853
	0.4311	0.3962
	0.4267	0.3946
	0.4297	0.4011

Bin	CIE X	CIE Y
30K-D	0.4465	0.4071
	0.4388	0.4043
	0.4355	0.3977
	0.4311	0.3962
	0.4259	0.3853
	0.4373	0.3893

Reference Range: 3000~3220K

Reference Range: 2870~3000K

Bin	CIE X	CIE Y
30K-F	0.4422	0.4113
	0.4328	0.4079
	0.4297	0.4011
	0.4388	0.4043
Reference Range: 2960~3150K		

Bin	CIE X	CIE Y
30K-G	0.4388	0.4043
	0.4297	0.4011
	0.4267	0.3946
	0.4355	0.3977
Reference Range: 2960~3150K		

Note: Color coordinates measurement allowance : ± 0.01 .

Forward Voltage Bins

Bin	Minimum Forward Voltage (V)	Maximum Forward Voltage (V)
5#8	5.80	5.90
5#9	5.90	6.00
6#0	6.00	6.10
6#1	6.10	6.20
6#2	6.20	6.30
6#3	6.30	6.40
6#4	6.40	6.50
6#5	6.50	6.60
6#6	6.60	6.70
6#7	6.70	6.80
6#8	6.80	6.90
6#9	6.90	7.00

Notes:

1. Forward voltage measurement tolerance: $\pm 0.1V$.
2. Forward voltage bins are defined at $I_f=150mA$ operation.

Mechanical Dimension

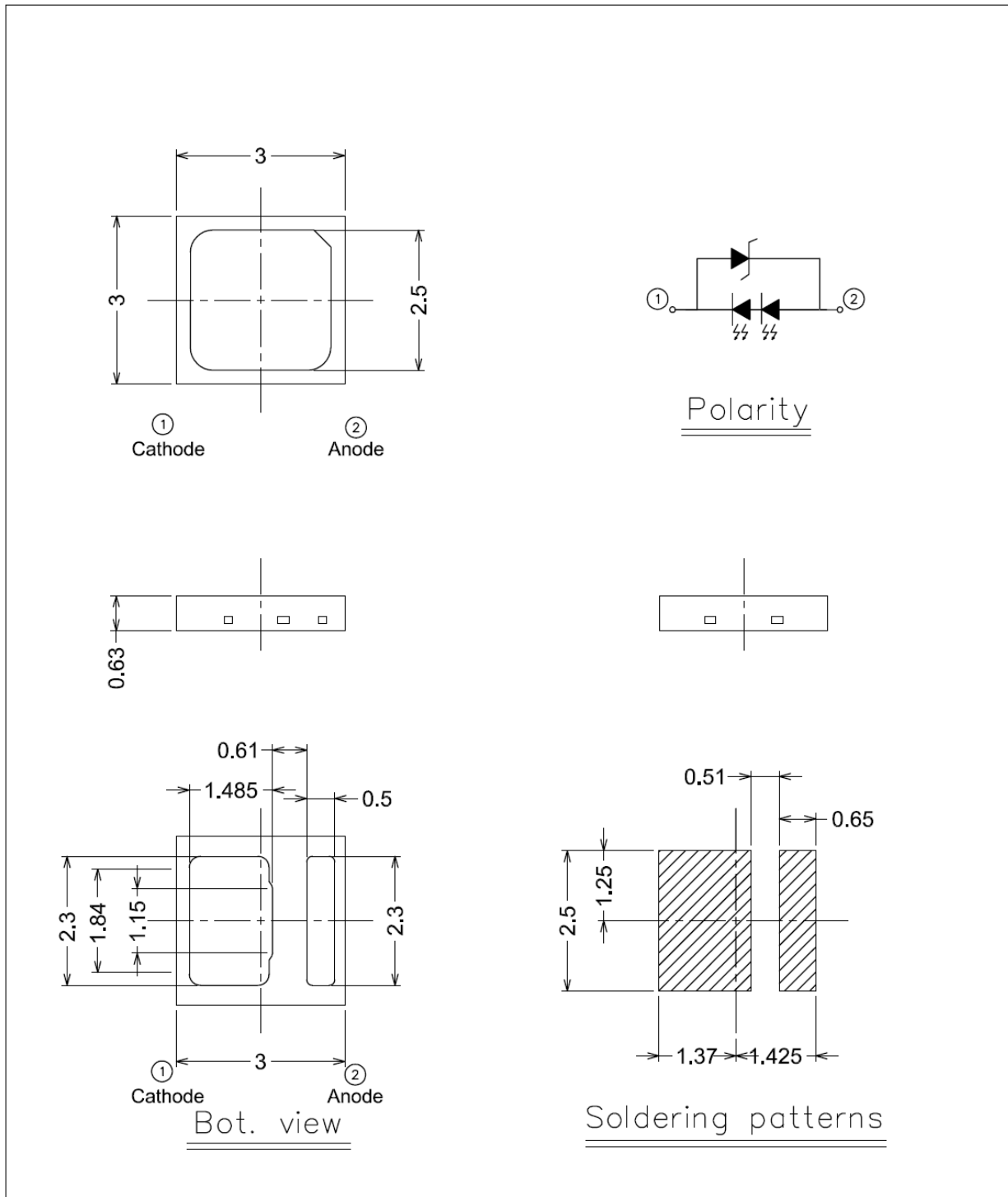

Notes:

1. Dimensions are in millimeters.

2. Tolerances unless mentioned are $\pm 0.2\text{mm}$.
3. The thermal pad is electrically unity from the Anode and contact pads.
4. Do not handle the device by the lens. Incorrect force applied to the lens may lead to the failure of devices.

Wavelength Characteristics
Relative Spectral Distribution
@ Solder Pad Temperature = 25

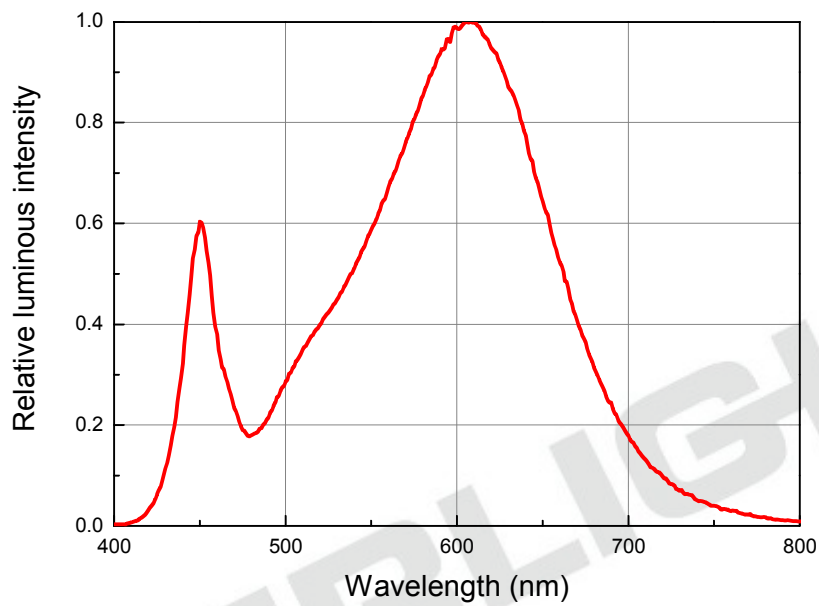

Typical Electrical Characteristics
@ Solder Pad Temperature = 25

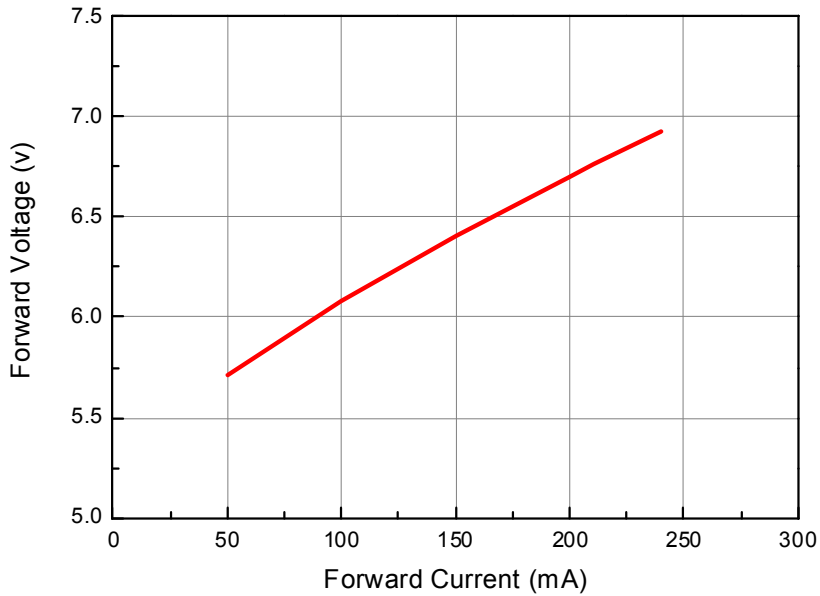

Typical Relative Luminous Flux vs. Forward Current

@ Solder Pad Temperature = 25

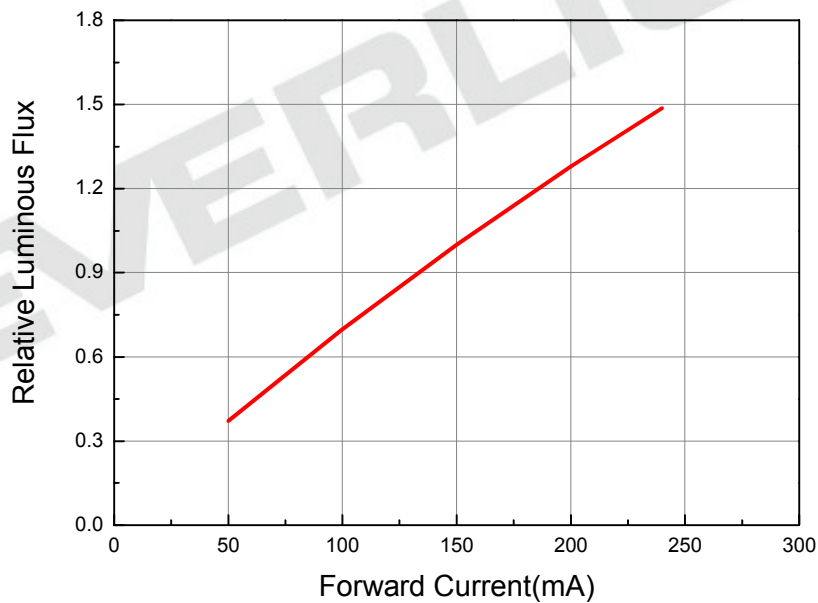

Typical Wavelength & Color Shift Characteristics vs. Forward Current

@ Solder Pad Temperature = 25

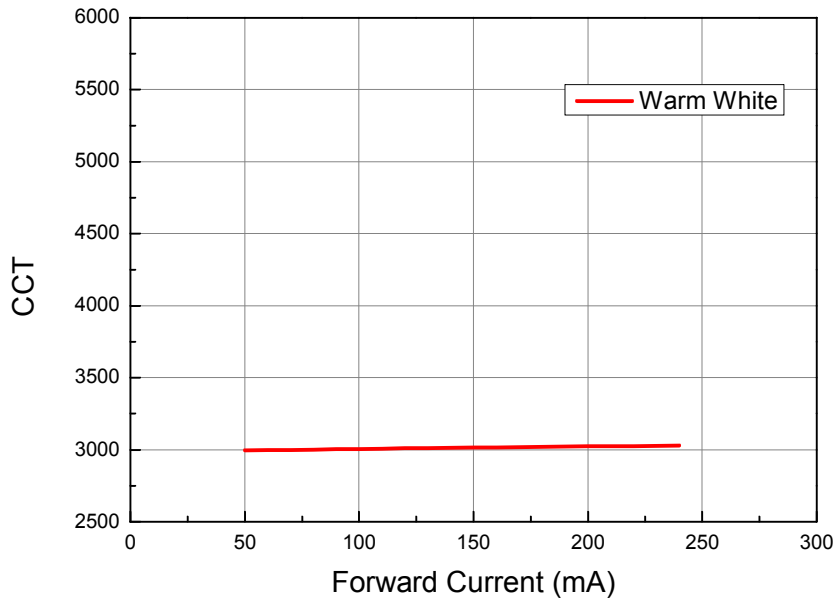

Relative Luminous Flux vs. Soldering Temperature

@Forward Current = 150mA

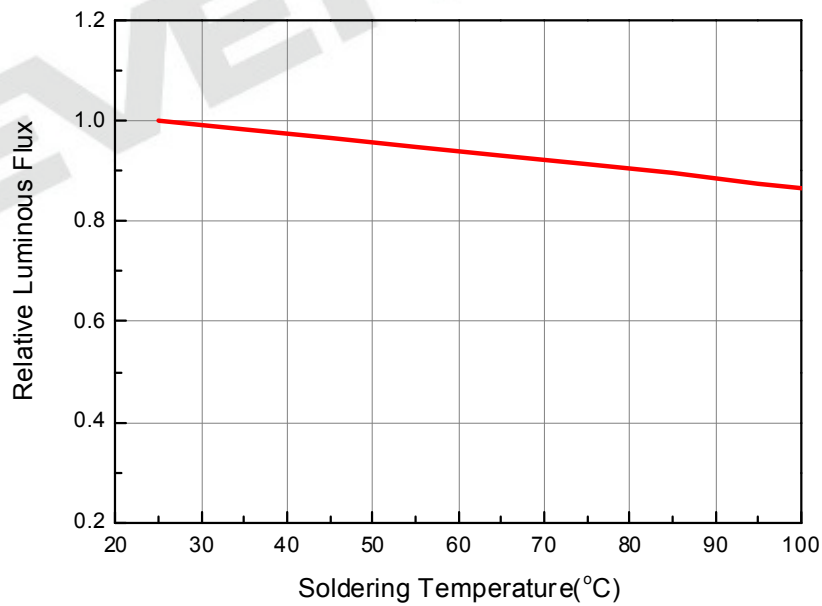

Forward Voltage vs. Soldering Temperature

@ Forward Current = 150mA

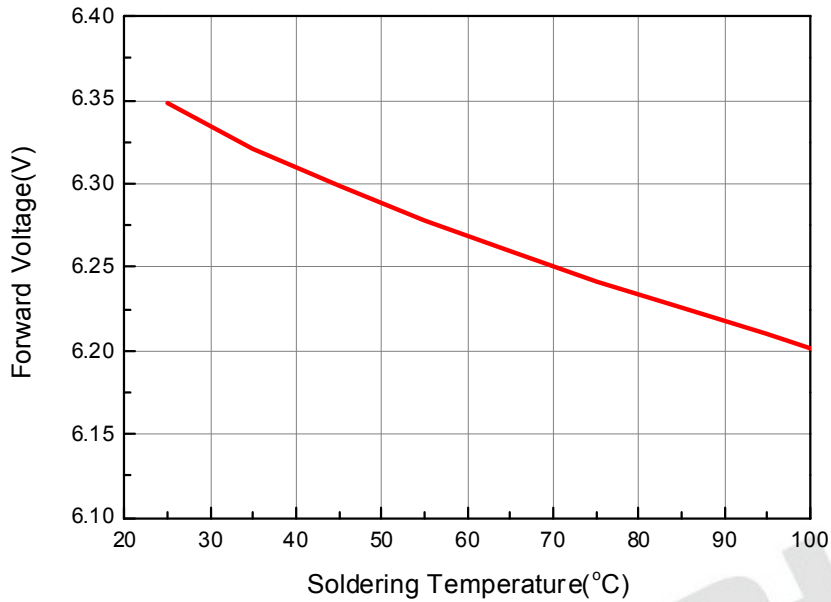

Forward Current Derating Curve

@ Junction Temperature <115

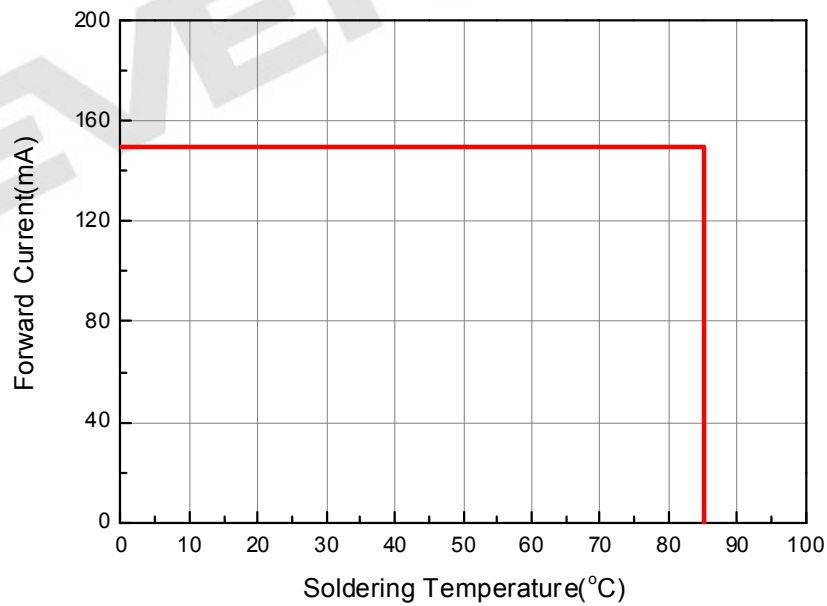

Typical Radiation Patterns
Typical Diagram Characteristics of Radiation

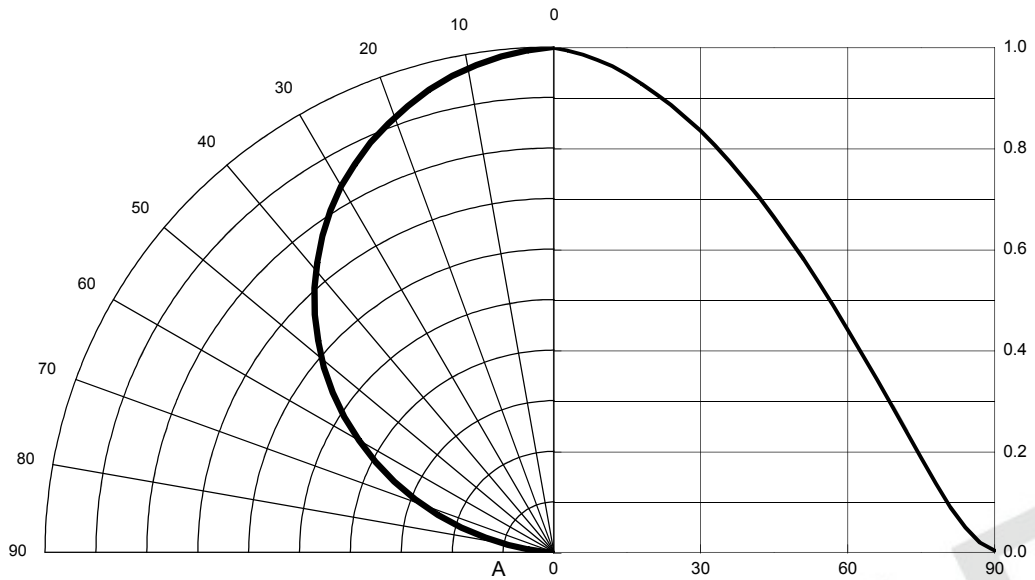

Notes:

1. $2\theta_{1/2}$ is the off axis angle from lamp centerline where the luminous intensity is 1/2 of the peak value.
2. View angle tolerance is $\pm 5^\circ$.

Emitter Tape Packaging
Carrier Tape Dimensions as the following:
Reel:2000pcs

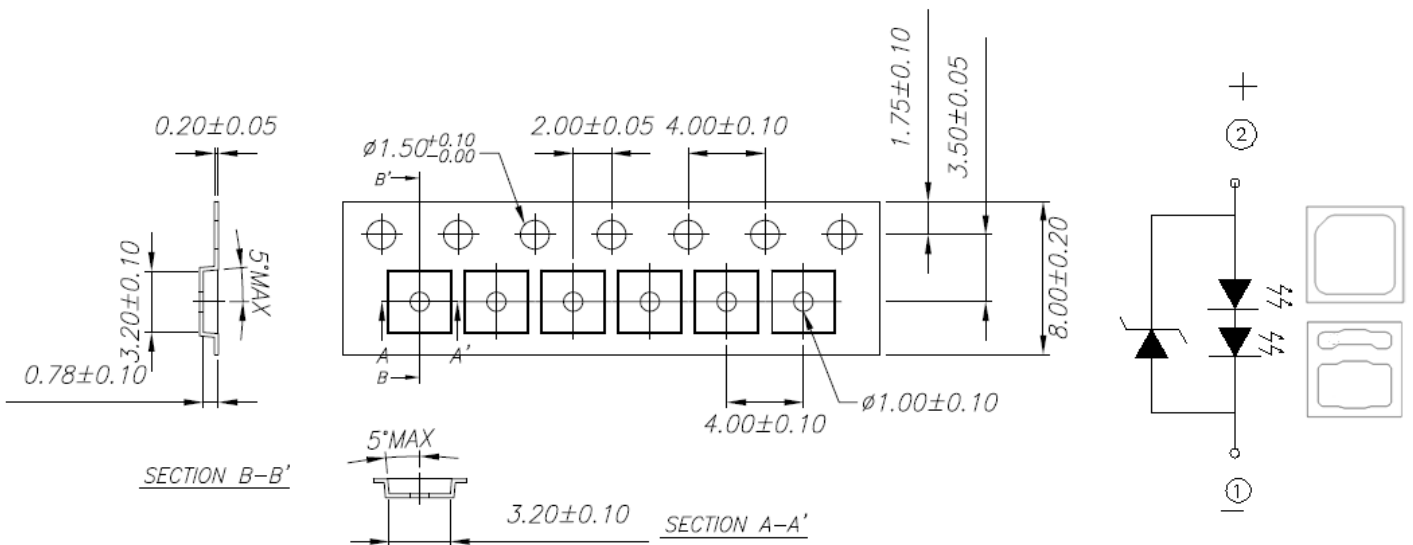

Notes:

1. Tolerance unless mentioned is $\pm 0.1\text{mm}$; Unit = mm
2. Minimum packing amount is 250/500/1000/2000 pcs per reel

Moisture Resistant Packaging

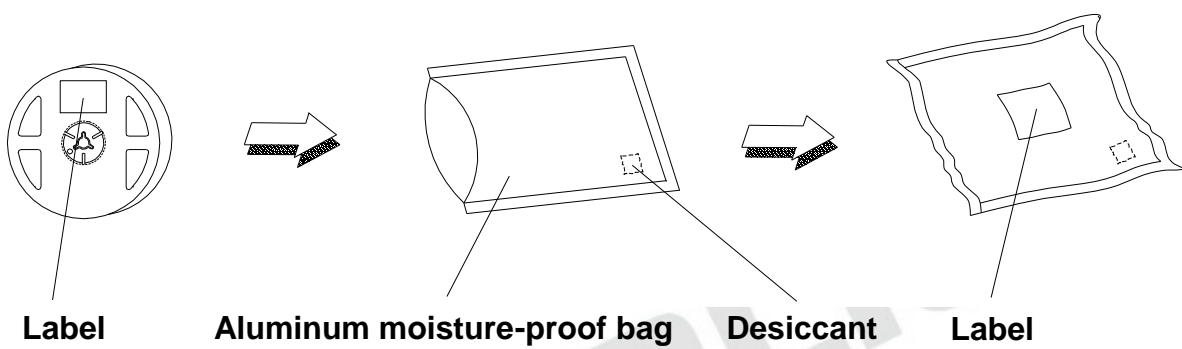

**Emitter Reel Packaging
Reel Dimensions**

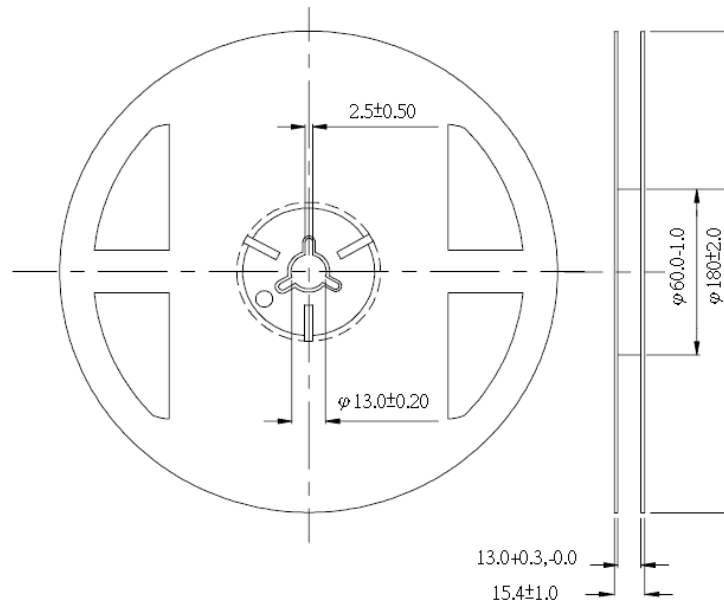

Notes:

1. Dimensions are in millimeters.
2. Tolerances unless mentioned are ± 0.1 mm.

Product Labeling

Label Explanation

CPN: Customer Specification (when required)

P/N : Everlight Americas Production Number

QTY: Packing Quantity

CAT: Luminous Flux (Brightness) Bin

HUE: Color Bin

REF: Forward Voltage Bin

LOT No: Lot Number

MADE IN TAIWAN: Production Place



Precautions for Use

1. Over-current-proof

Customer must apply resistors for protection; otherwise slight voltage shift will cause big current change (Burn out will happen).

2. Storage

2.1 Before the package is opened: The LEDs should be stored at 30°C or less and 50%RH or less after being shipped from Everlight Americas. The storage life is 6 months. If the LEDs are to be stored for more than 6 months, they should be stored in a sealed container with a nitrogen atmosphere and moisture absorbent material.

2.2 After opening the package: The LED's should be stored under 30°C or less and 30%RH or less. The LED should be used within 168hrs (7days) after opening the package. If unused LEDs remain, they should be stored in moisture proof packages.

2.3 Before using LEDs: The LEDs should be baked under the following conditions: pre-curing at 60±5°C for 24 hours.

2.4 Do not stack assemblies containing Everlight Americas EAHP3030WA1 LEDs to prevent damage to the optical surface of LEDs. Forces applied to the optical surface may result in the surface being damaged.

3. Soldering Condition

3.1 Pb-free solder temperature profile

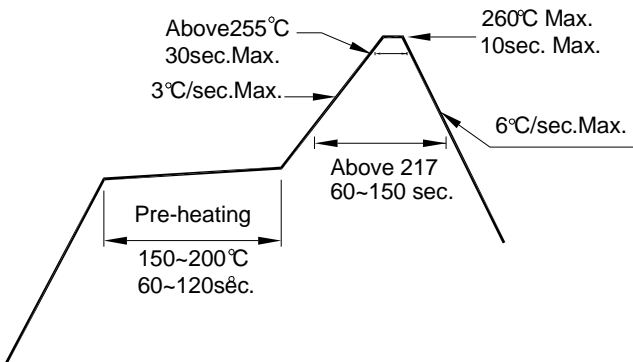

3.2 Reflow soldering should not be done more than two times.

3.3 When soldering, do not put stress on the LEDs during heating.

3.4 After soldering, do not warp the circuit board.

4. Soldering Iron

Each terminal is to go to the tip of soldering iron temperature less than 350 for 3 seconds within once in less than the soldering iron capacity 25W. Leave two seconds and more intervals, and do soldering of each terminal. Be careful because the damage of the product is often started at the time of the hand solder.

5. Repairing

Repair should not be done after the LEDs have been soldered. When repairing is unavoidable, a double-head soldering iron should be used (as below figure). It should be confirmed beforehand whether the characteristics of the LEDs will or will not be damaged by repairing.

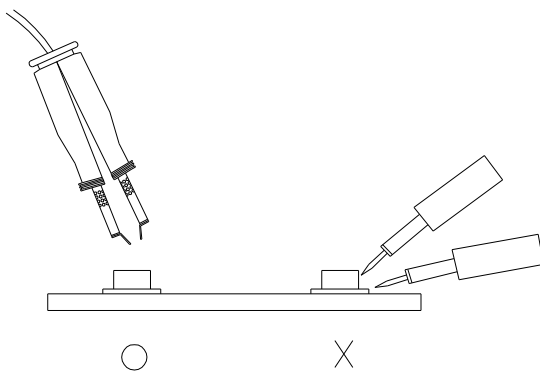

Storage Conditions

- Before the package is opened. The LEDs should be stored at 30°C or less and 85%RH or less after being shipped from Everlight Americas and the storage life limits are 1 year. The LEDs can be stored up to 3 years If in a sealed container with a nitrogen atmosphere and moisture absorbent material.
- After opening the package: The LED's floor life is 1 year under 30 or less and 60%RH or less. The LED should be soldered with 168hrs (7days) after opening the package. If unused LEDs remain, it should be stored in moisture proof packages.
- If the moisture absorbent material (silica gel) has faded away or the LEDs have exceeded the storage time, baking treatment should be performed using the following conditions. Baking treatment: 60±5 for 24 hours.

EVERLIGHT

Revision History

Version: 1

Created by: Sherry Chen

Page	Subjects (major change in previous version)	Date of change

EVERLIGHT