



A TIME AND PLACE *for everything*™

TW5340
Integrated GPS/ GLONASS
Receiver/Antenna
User Manual

Visit us on the web:
www.tallysman.com

Document # 61-0009-0

Document Amendment Record

Revision	Date	Comments
Rev 1_0	7 Nov 2014	Initial release
Rev 1_1	11 Nov 2014	Minor edits
Rev 1_2	10 Dec 2014	Edit of wake up pin
Rev 1_3	4 Mar 2015	TW5340 Rev 3 Standby Mode support
Rev 1.4	6 May 2015	Correction to configurator and clarification regarding 10 Hz operation
Rev 1.5	23 June 2015	Connector Pin out changes Updated “walking mode” & “Position hold mode”
Rev 1.6	31 July 2015	Added changes to return to factory defaults & loading new firmware
Rev 1.7	3 Sept 2015	Added Accuracy figures and Salt spray info
Rev 1.8	30 Oct 2015	Updated Standby mode info
Rev 1.9	15 Jan 2016	Corrections to section 7, Note 1

Copyright

Copyright © 2014 2016 Tallysman Wireless Inc. All Rights Reserved.

This document and the subject matter herein are proprietary items to which Tallysman Wireless Inc. retains an exclusive right to reproduction, manufacture and sale. This document is submitted in confidence, for the use of the recipient alone, or in conjunction with Tallysman Wireless Inc. and its licensees, and for no other purpose whatsoever unless permission for further disclosure is expressly granted in writing. Information in this document is subject to change without notice.

Tallysman Wireless Inc.
106 Schneider Road, Unit 3
Ottawa ON K2K 1Y2 Canada
Tel: 613 591 3131
Fax: 613 591 3121

Table of Contents

1 Downloads 5

2 Introduction 5

 2.1 Position Accuracy 7

 2.2 CE Marking 7

3 Variants 8

 3.1 Ordering Information 8

 3.2 Build Information 8

4 GNSS Systems..... 8

 4.1 GPS 8

 4.2 GLONASS 8

5 NMEA Packet Format 9

6 Software Utilities 9

 6.1 Open Source GPS Software Utilities..... 9

7 Hardware Interface 10

 7.1 TW5340 Installation 11

8 Testing..... 11

 8.1 Baud Rate 11

 8.2 Test Adaptor Pin outs..... 12

 8.3 NMEA Output test..... 12

 8.4 Satellite Output Test 13

 8.5 Power 14

 8.6 1PPS..... 14

 Cable Delays:..... 15

 Fix Quality (1PPS Qualification)/Standby..... 15

 8.7 Wake Up Input 16

9 Operating Modes 16

 9.1 Navigation Mode..... 16

 9.2 Standby Mode 17

 Initialize GPS time 17

10	Satellite Based Augmentation System (SBAS)	19
11	TW5340 Configuration.....	21
11.1	INTERFACE TAB.....	22
11.2	GENERAL TAB.....	22
11.3	MESSAGES TAB	24
11.4	CONSTELLATIONS	28
11.5	TRACKING	29
11.6	1 PPS TAB.....	31
11.7	STANDBY TAB.....	33
12	NMEA Message Reference.....	34
	RMC.....	34
	GGA	35
	GSA.....	36
	GSV	37
	VTG.....	38
	GLL.....	38
	GNGNS	39
	ZDA.....	40
	Usage.....	40
	WAAS	41
13	Loading New Firmware	42
13.1	Custom Firmware	42
13.2	Factory Defaults.....	43

1 Downloads

For the latest TW5340 download package click on the following link

<http://tallysman.com/downloads/45-0030-0%20TW5340.zip>

2 Introduction

The TW5340 GNSS receiver/antenna incorporates the ST STA8088 state of the art receiver which provides 32 high sensitivity tracking channels which can be assigned to acquire and track GPS and GLONASS signals simultaneously. The TW5340 is designed for use in professional grade applications such as precision timing, network synchronization, low current battery and vehicle tracking applications.

The TW5340 family of GNSS receiver/antennas employs Tallysman's Accutenna™ dual feed antenna patch technology which greatly improves rejection of multi-path signals across the whole GNSS band, resulting in much higher precision than single feed antennas which are typically tuned to a single GNSS frequency.

The TW5340 supports ST Microelectronics Autonomous A-GPS which accelerates GPS positioning by predicting satellite ephemeris data based on previous observations, this results in extremely fast Time-To-First-Fix.

The TW5340 supports 3 modes of operation; Navigation, Standby and Low Current (expert mode parameters only). A hardware interface is provided for external application to control the Standby mode, this is especially useful in applications that require low current drain.

The TW5340 outputs standard NMEA 0183 output with navigation updates rates up to 10Hz are supported. Three (3) messages lists can be output each with different output rates.

The TW5340 is available with RS232, and CMOS interfaces and input voltage options of 3.3V, 5.0V and 12V.

A standard one pulse-per-second 1PPS output is available as a single ended output or as a differential output at RS422 levels. The 1PPS can be configured to be synchronized to UTC, GPS or GLONASS reference time.

Tallysman Windows™ based TW5340 Configurator application provides for simple configuration of TW5340 parameters such as tracking, Standby mode operation, 1 PPS timing, constellations, SBAS etc.



Figure 1 TW5340

The TW5340 is housed in an industrial grade weatherproof IP67 enclosure for 19mm diameter ($\frac{3}{4}$ ") thru-hole mount or mast mount installations. It is available with low profile radome for use in tracking applications and with a conical radome for timing applications.



Figure 2 TW5340

Features

- Standalone Integrated GPS/GLONASS Receiver/Antenna
- 32 channel simultaneous operation
- High performance tracking (-162dBm)
- Fast time to first fix (35mS)
- *Accutenna* – Dual feed antenna (high multipath rejection)
- SBAS Capable

- Low noise LNA and SAW band-pass filter
- NMEA 0183 output; up to 3 lists
- Differential 1PPS output
- 1PPS Qualification
- Configuration information saved across power cycles
- Waterproof enclosure (IP67)
- Standby low current mode
- RoHS compliant

2.1 Position Accuracy

Position accuracy verifies long time static accuracy and stability. The results below show the circular error probability (CEP) and the spherical error probability (SEP), CEP and SEP are respectively the probability of a point falling within a circle or sphere or datum radius around its reported position.

Duration: 22h 21m 11s

Cn0 range: 39-47 dB (Full Sky)

GNSS Signal: GPS+GLO

Error Positioning	SBAS OFF		SBAS ON		Unit
	CEP	SEP	CEP	SEP	
50%	1.6	3.1	1.5	2.5	m
90%	2.75	6.9	2.6	3.9	m
95%	3.1	8.1	2.8	5.1	m
99%	3.6	10.2	3.1	7.5	m

Position Accuracy

2.2 CE Marking

The TW5340 has been tested against the following specifications:

- Electromagnetic compatibility testing to EN 55022
- Radiated RF immunity, EN 61000-4-3,
- Electrical fast transient/burst, EN 61000-4-4
- Conducted RF immunity, EN 61000-4-6
- Salt Spray, MIL-STD-810F section 509.4

3 Variants

The TW534X is offered in the following variants:

PRODUCT	PWR	GND	SIGNALS					
TW5340 (RS232)	3. 3V, 5V, 12V	<input checked="" type="checkbox"/>	TX (RS232)	RX (RS232)	1PPS_A (RS422)	1PPS_B RS422	Fix Qual /Standby	Wake Up
TW5340 (CMOS)	3.3V, 5V	<input checked="" type="checkbox"/>	TX (CMOS)	RX (CMOS)	1PPS_A (RS422)	1PPS_B RS422	Fix Qual /Standby	Wake up

Table 1

3.1 Ordering Information

Part Numbering:

33-5340-X-YY GPS/GLONASS Smart Antenna

33-5341-X-YY Non-magnetic, GPS/GLONASS Smart Antenna

27-0045-1 TW5340 Test Adaptor

Where X= interface/voltage (0= RS232 12V; 1 = RS232 5V; 2 = CMOS 5V, 3 = CMOS, 3.3V, 4 = N/A, 5 = RS232 3.3V), YY= Radome (00= grey conical, 10=grey low profile, 01=white conical, 11=white low profile).

3.2 Build Information

The current build information is:

- **Hardware Build: Rev 4.2**
- **Hardware build Rev 4.3** (25m cable variant)
- **Software build: 1.1.02** (The TW5340 configurator shows the software version in the General tab/Text Message

4 GNSS Systems

Tallysman TW5340 family of GNSS Receiver/Antennas are multi-GNSS receivers that receive and track GPS, and GLONASS, signals simultaneously.

4.1 GPS

The US Global Position System (GPS) uses L1C/A signals at 1575.42 MHz to determine position.

4.2 GLONASS

The Russian GLONASS satellite system is an alternative system to the US-based Global Positioning System (GPS).

5 NMEA Packet Format

The TW5340 serial interface is based on the NMEA-0183 protocol standard.

The NMEA -0183 protocol starts with a "\$" character followed by a NMEA Talker ID.

"GP" indicates Talker ID for the GPS constellation

"GL" indicates Talker ID the GLONASS constellation

"GN" indicates Talker ID for all constellations

6 Software Utilities

6.1 Open Source GPS Software Utilities

The following open source GPS utility can be used to display the GPS and GLONASS GGA and GSV messages with Talker ID's GP and GL.

<http://www.visualgps.net/VisualGPSView/>

Note: "GN"Talker ID's are not currently supported by this application.

This VisualGPS application can log data which can subsequently be imported into the following data conversion application for easy display tracking data on Goggle maps:

<http://www.gpsbabel.org/>

7 Hardware Interface

The TW5340 is provided with a 5 m cable terminated in a RJ45 connector.

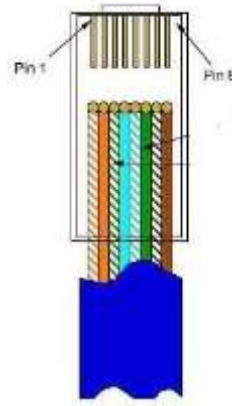

Figure 3

Wire Color	Signal	Comments	Pin #
Brown	Power	12V, 5V or 3.3V depending on model	8
Brown/White	Gnd	0V	7
Blue/White	RX into the TW5340	RS232 level (+/-6V) CMOS 3.3V	5
Orange	TX out of the TW5340	RS232 level (+/-6.6V) CMOS 3.3V	6
Green/White	Differential 1PPS output	1PPS_B (0 to 2.0V levels).	1
Green	Differential 1PPS output	1PPS_A (0 to 2.0V levels).	2
Orange/White	Wake up Input	Wake Up -input Low <i>“not supported on Rev 1_0 release”</i>	3
Blue	Fix Quality (1PPS Qualification) /Standby status	Continuous mode (0 to 3.3V)	4

Table 2

Note 1:

- *TW5340 cable outputs have been changed on Rev 4 to provide better noise immunity of the 1PPS outputs. The following pin changes were made:*
- *1PPS B was pin 4 & is now pin 1*
- *1PPS A was pin 3 & is now pin 2*
- *Wake up input was pin 2 & is now 3*
- *Fix Quality/Standby status was pin 1 & is now pin 4*

7.1 TW5340 Installation

For best results the TW5340 GPS Receiver/Antenna should be installed with a clear view of the sky. The GPS Receiver/Antenna will obtain a 3D fix GPS fix with a minimum of 4 satellites.

8 Testing

Tallysman TW5340 DB9 Test adaptor (part # 27-0045-1) connects to the RJ45 connector on the TW5340 and provides a DB 9 COM port connection to a PC for testing purposes. Figure 4 shows the test system set-up, connect the adaptor RED wire to the positive supply and the Black wire to Gnd.

If the TW5340 outputs at RS232 levels the Test Adaptor can be plugged directly into the PC Com Port, if the TW5340 outputs at CMOS levels a CMOS to RS232 converter will be required between the Test Adaptor and the PC COM port.

8.1 Baud Rate

The default output from the TW5340 is 5 digit resolution GGA, GSV and Usage messages at 115,200 baud. See section 12 for message format information.

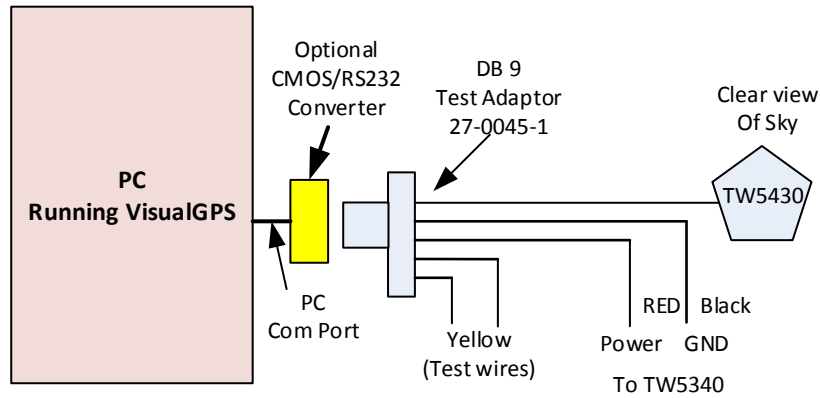

Note: The Yellow test wire are only used when resetting parameters to factory defaults

Figure 4

8.2 Test Adaptor Pin outs

TW5430	DB9 Test Adaptor (27-0045-1)
Power (Pin 8 Brown)	
Gnd (Pin 7 Brown/White)	Pin 5 Gnd
TX out (Pin 6 Orange)	Pin 2 RX into PC
RX in (Pin 5 Blue/White)	Pin 3 TX out of PC
** Reset factory default 1 (Yellow)	Pin 4 DTR out of PC
** Reset factory default 1 (Yellow) (Pin 3 Wake up)	

Table 3

** Only used to revert to default parameters to factory defaults, see section 13.2

8.3 NMEA Output test

Run the VisualGPS application (see section 6.1), select the NMEA tab to display message output.

Set COM Port: Select Tools/Connect to GPS

8.5 Power

The TW5340 operates from 3.3V, 5V and 6 to 16 volts. Overvoltage and transient protection is provided making it suitable for installation in the harshest of vehicle installations.

On the RJ45 connector shown in Figure 3:

- Connect the BROWN wire on the TW5340 to Positive supply
- Connect the BROWN/WHITE wire on the TW5340 to Gnd

8.6 1PPS

The TW5340 provides a one (1) pulse-per second output signal for timing purposes.

Differential 1PSS outputs are provided at RS422 levels.

The 1PPS signal can be synchronized to GPS or GLONASS reference times to an accuracy within 50 nanoseconds.

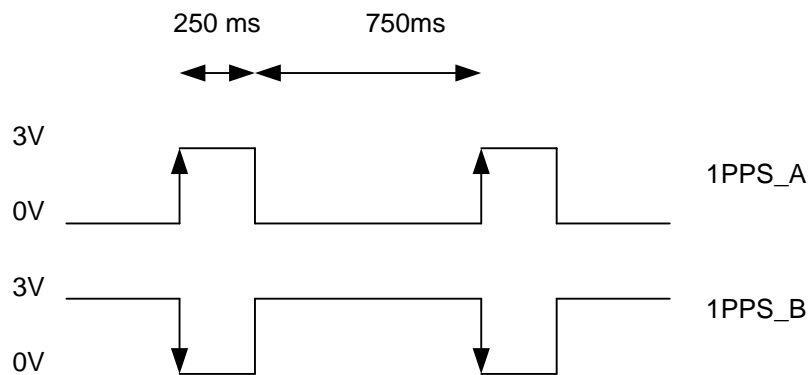

Figure 7

The default pulse width is 250 ms, but is configurable from 100 ms to 500 ms. Typical jitter is 20ns. Signal levels are differential, 0.V to 2.03V.

After obtaining a GPS fix, the 1PPS output will be accurately maintained even when tracking only one satellite. Once synchronized the 1PPS maintains synchronization accuracy with no GPS reception by fly-wheeling for a period.

The following examples are provided for termination of the 1PPS signals.

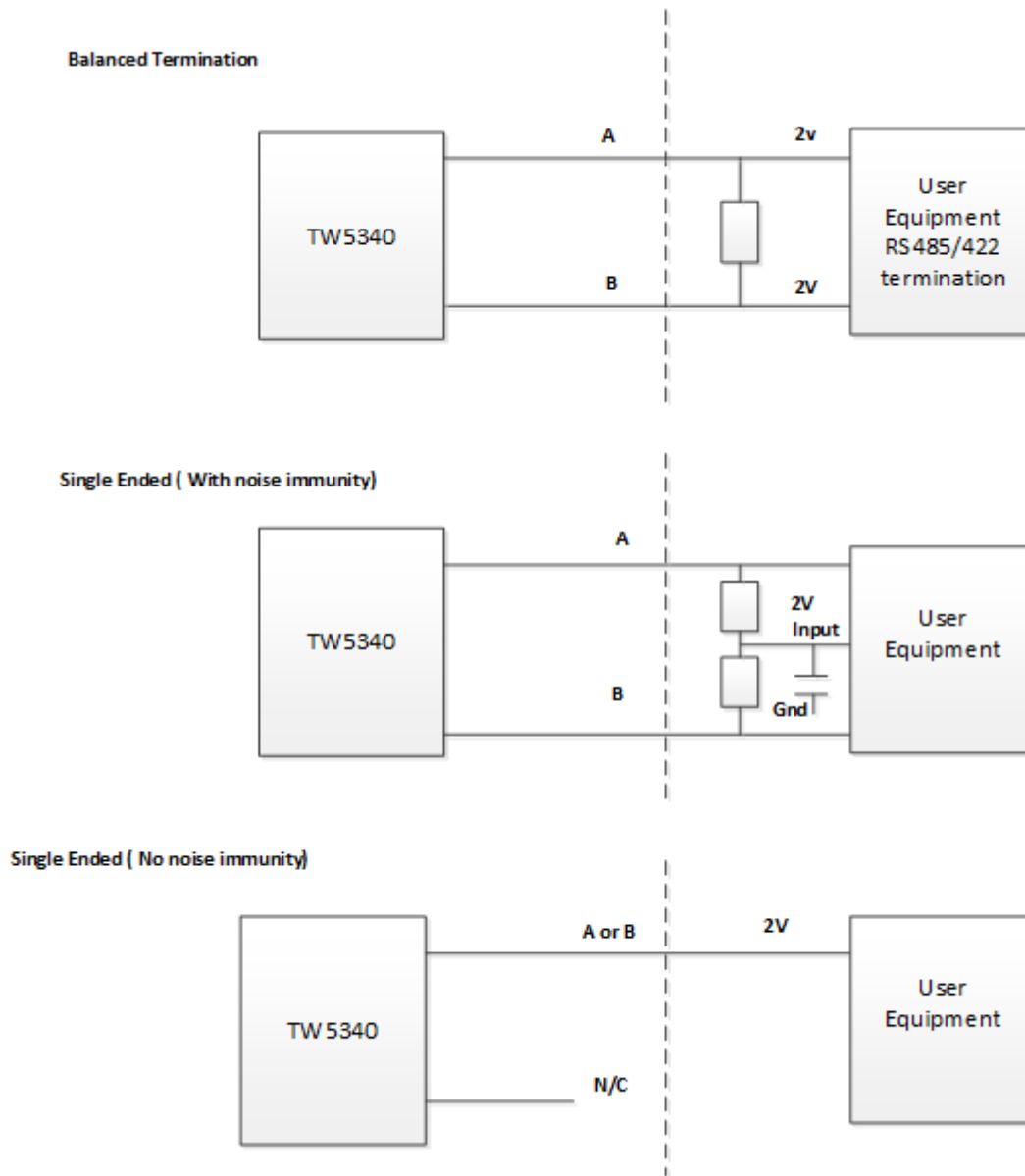

Figure 8

The balanced driver in the TW5430 is an Intersil 3179E. Please check the data sheet for additional information.

Cable Delays:

The timing of the 1PPS pulse depends on the length of both antenna and interface cables, to account for cable delays add 3ns for each meter of cable.

Fix Quality (1PPS Qualification)/Standby

This output has a dual function, by default it is a Fix Quality (1PPS qualification) output.

If the device is configured to operate in Standby mode the output provides positive feedback that the device has entered Standby mode.

Fix Quality (1PPS Qualification)

A 1PPS qualification signal is provided to indicate when the 1PPS output is valid, qualification is based on the configured Fix Quality PDOP value, see section 11.2.

Figure 9 shows the internal 1PPS qualification status of the TW5340. Once the 1PPS status is detected as good, a Fix Quality Start Delay can be inserted before the 1PPS qualification signal is output to ensure that the TW5340 has time to average out the satellite clocks and provide a stable 1PPS output.

On loss of 1PPS qualification status the 1PPS qualification output is maintained for the Fix Quality Flywheel time, see section 11.2.

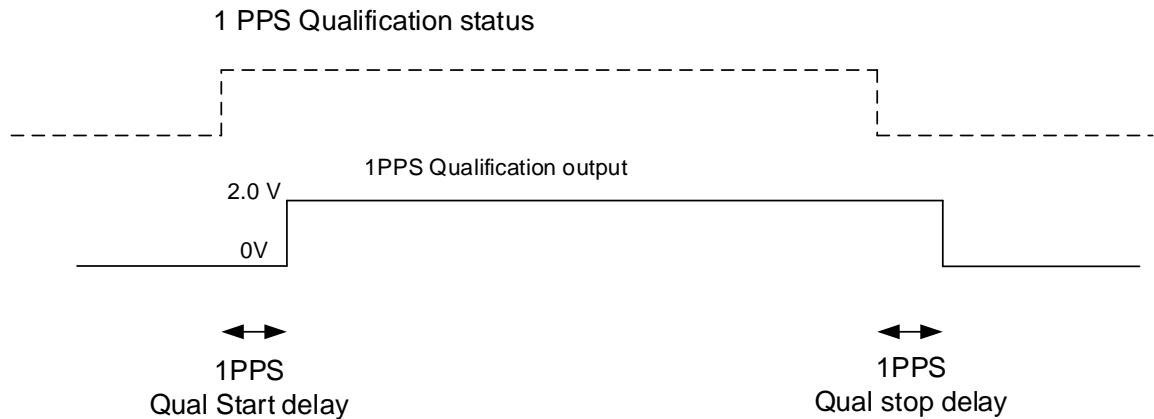

Figure 9

8.7 Wake Up Input

The Wakeup input is pulled high by the TW5340. It must be left in this state to enter standby mode. When in standby, the wakeup input must be pulled to ground to cause the TW5340 to exit Standby mode and return to Navigation mode.

9 Operating Modes

The TW5340 has three operating modes:

9.1 Navigation Mode

The TW5340 uses the acquisition engine continually resulting in the shortest time to first fix. It searches all possible satellites until the almanac is completely downloaded, the receiver then switches to the tracking engine to lower power consumption.

9.2 Standby Mode

Standby mode stops the navigation operation and all supply inputs are powered down and power drain is reduced. Standby mode is entered by External control (see below)

In Navigation mode the current consumption is approximately 70 mA, and in Standby mode is approximately 1 mA,

The Standby status output pin provides a positive feedback that the device has entered Standby mode. When Not In standby the output is pulled high, when in standby the output is floating.

External control

The W5340 can enter Standby mode by issuing a “\$PSTMGOTOSTANDBY” command.

\$PSTMGOTOSTANDBY,1,<sleep time>,0,<sleep time>

<Sleep time> is the number of seconds to remain in standby mode. Note the two sleep times in the command must be identical.

The TW5340 can be woken from standby state by the wakeup pin.

Pin 3 on the TW5340 can be used to wake the device up. To exit Standby mode the Wake-Up pin must be pulsed low for approximately 1 ms by an open collector output.

Note: If the TW5340 is in Standby mode for greater 30 minutes the ephemeris data may old and have to be re-acquired before a GNSS position can be resolved resulting in a cold start of approximately 50 to 90 seconds.

As a rule of thumb the TW5340 should be on for 30 seconds every 30 minutes to guarantee a hot start of less than 10seconds.

Note: For applications that need to conserve power by waking up quickly from standby mode and getting a fix as quickly as possible it is recommended that both GPS & GLONASS constellations are enabled

Initialize GPS time

Acquisition of a position fix can be sped up by initializing the TW5430 with the GPS time. The following NMEA command can be used **\$PSTMINITTIME**

\$PSTMINITTIME,<Day>,<Month>,<Year>,<Hour>,<Minute>,<Second><cr><lf>

Parameter	Format	Description
Day	dd - decimal, 2 digits	Day of month (01 to 31)
Month	mm – Decimal, 2 digits	Month (01 to 12)
Year	YYYY – Decimal, 4 digits	Year (194 -)
Hour	HH – Decimal, 2 digits	Hour (00 to 23)
Minute	MM _ Decimal, 2 digits	Minute (00 to 59)
Second	SS – Decimal, 2 digits	Second (00 to 59)

Table 4

The following message will be output on the NMEA communications channel

\$PSTMINITTIMEOK<cr><lf> If success

\$PSTMINITTIMEERROR<cr><lf> If no success

10 Satellite Based Augmentation System (SBAS)

The TW5340 can be configured to use satellite corrections transmitted by SBAS satellites to provide greater positioning accuracy. There are three compatible SBAS systems which are integrated to provide a seamless worldwide navigation system.

Configure the SBAS satellite ID closest to your Location.

Service	Satellite Name	NMEA	Satellite ID (PRN)	Location (longitude)
WAAS	Inmarsat 4-F3	46	133	98° W
WAAS	Galaxy 15	48	135	133° W
WAAS	Anik F1R	51	138	107.3° W
EGNOS	Inmarsat 3-F2	33	120	15.5° W
EGNOS	Inmarsat 4-F2	39	126	25° E
EGNOS	Inmarsat 3-F1	44	131	64.5° E
MSAS	MTSAT-1R	42	129	140° E
MSAS	MTSAT-2	50	137	145° E

Table 5

The default satellite ID is 133 (Suitable for longitudes of those of the Eastern US).

The TW5340 configurator supports the addition of two future SBAS satellite ID's.

Three SBAS are already operational (WAAS, MSAS, EGNOS), three are under implementation (GAGAN, SDCM, SNAS) while others are under feasibility studies, as is the case of SACCSA.

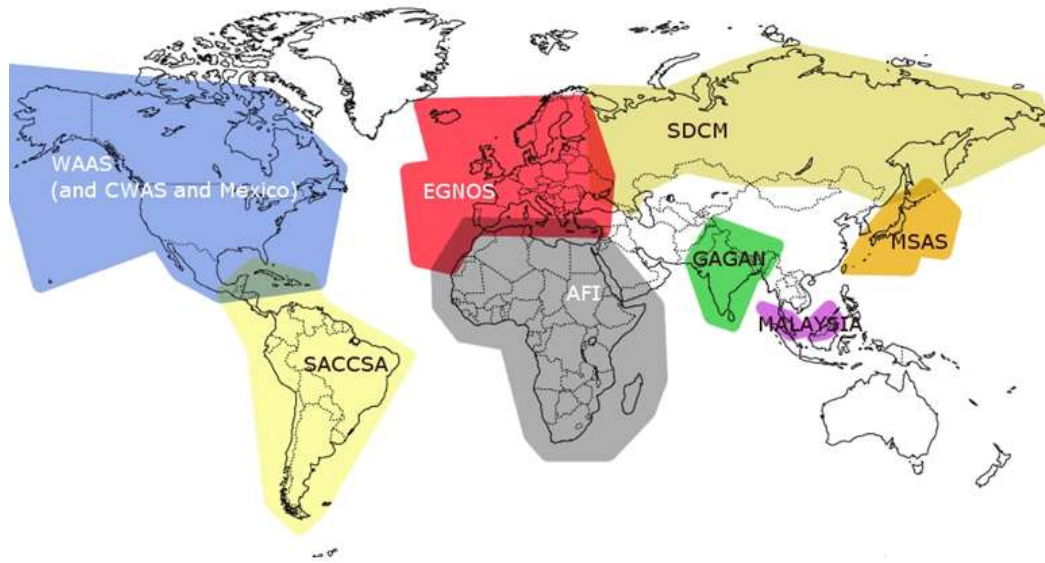

Figure 10

More information can be found by clicking on the following link:

http://www.navipedia.net/index.php/SBAS_Systems

11 TW5340 Configuration

Tallysman provides downloadable software package (part # 45-0030-0) which includes a Windows based “Configurator” for reading and writing of operating parameters and a user manual.

For the latest information click on the following link

<http://tallysman.com/downloads/45-0030-0%20TW5340.zip>

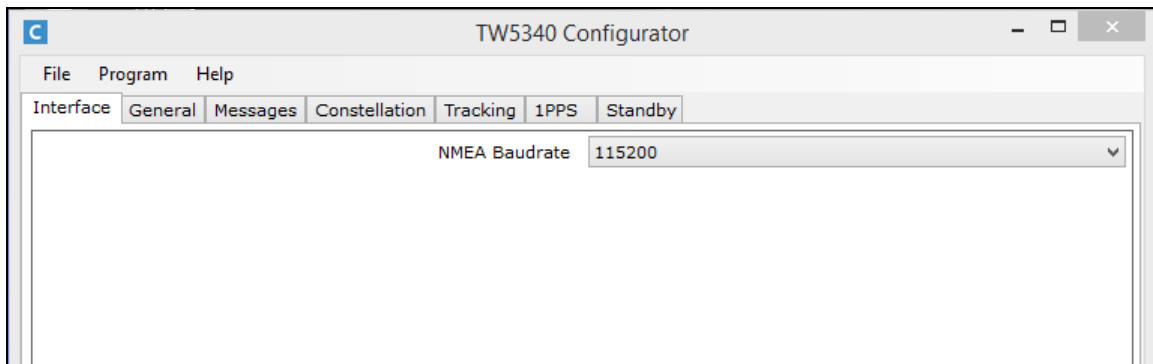

Figure 11

Connect the PC to the TW5340 using the Test Adaptor (27-0045-1)

Set the TW5340 Configurator to the COM port speed of the TW5340 (115200 baud is default).

- Select **Program/Read** to read the parameters in the TW5300.
(Note: It is recommended that the default parameters are saved, so that you can always retrieve and Write them back if required).
- To write a new set of parameters to the TW5340 select **Program/Write**
- The configuration file can be save by selecting **File/Save**.

Note: Most configuration parameters changes do not take effect until the TW5340 is reset i.e. power cycled.

The configurator provides configuration of the “general” parameters of the TW5340. Contact Tallysman Wireless to discuss specific parameters that may not be listed.

11.1 INTERFACE TAB

Baud Rate: (default 115200)

Sets the operating baud rate of the TW5340. If the baud rate is changed and written to the TW5340 remember to change the Configurator baud rate to match.

11.2 GENERAL TAB

Enable watchdog:

Enable to set the internal watchdog. TW5340 resets when watchdog times out.

Enable Fix Quality output:

Enables output on Pin 2 of the TW5340 to indicate Fix Quality OK (1PPS Qualification)

Fix Quality Start Delay: (default 10 ms)

Inserts a delay before asserting Fix Quality OK.

This is the period that the TW5340 waits after detection of a good fix before outputting a 1PPS qualification signal. The TW5340 uses this period to ensure that the TW5300 has time to average out the satellite clocks and provide a stable 1PPS output.

Fix Quality Flywheel: (default 10ms)

On loss of Fix the Fix quality output flywheels for a period set by this parameter.

Fix Quality PDOP Threshold: (default 12)

The Dilution of precision (DOP) required for Fix Quality OK.

DOP Value	Rating	Description
1	Ideal	This is the highest possible confidence level to be used for applications demanding the highest possible precision at all times.
1-2	Excellent	At this confidence level, positional measurements are considered accurate enough to meet all but the most sensitive applications.
2-5	Good	Represents a level that marks the minimum appropriate for making business decisions. Positional measurements could be used to make reliable in-route navigation suggestions to the user.
5-10	Moderate	Positional measurements could be used for calculations, but the fix quality could still be improved. A more open view of the sky is recommended.
10-20	Fair	Represents a low confidence level. Positional measurements should be discarded or used only to indicate a very rough estimate of the current location.
>20	Poor	At this level, measurements are inaccurate by as much as 300 meters with a 6 meter accurate device ($50 \text{ DOP} \times 6 \text{ meters}$) and should be discarded.

Table 6

FIX Rate (Sec) :

Defines the time in seconds between fixes. E.g., if a Message list output rate of 10 Hz is required, then the Fix Rate per second should be set to 0.1 sec, or (1/ 10 Hz).

Text Message:

The user modifiable text message which is output on reset.

CPU Clock Speed:

Sets the CPU clock rate to support the required fix rate.

The lower the speed the less current draw. 52Mhz (Osc) provides the lowest operating power.

Higher speeds (104 Mhz minimum) will be required to support higher fix rates or accurate timing i.e. 1PPS or NMEA output relative to a fix.

The "Usage" message provides information on % of CPU usage, see section 12 for Usage message format.

11.3 MESSAGES TAB

SBAS Satellite on GSV Message:

The SBAS satellite information is output in a GSV message.

NMEA 3.01 Mode field on RMC, VTG, and GLL messages:

Setting this option will enable a "mode" field to be appended to the RMC, VTG and GLL sentences, as required by the NMEA 3.01 specification. (See the "mode indicator" in the GNGNS NMEA message, section 12 under GNGNS).

Start Up header message:

Outputs device information on reset, including version, model, ESN, and user text message.

Current Configuration message on startup:

Outputs the configuration parameters of the TW5340 on startup.

Use GNGSV in place of GLGSV or GPGSV:

The GSV message can be configured to be output with GN talker ID.

Use GNGSA in place of GLGSA or GPGSA:

The GSA message are be configured to be output with GN talker ID.

Decimal digits in GGA:

Sets the number of decimal digits in GGA output.

Decimal Digits in RMC and GLL

Sets the number of decimal digits in RMC and GLL output.

NMEA Talker ID: (Default is "P")

Assign a unique talker ID to these non-constellation message types. This NMEA talker ID relates to the following message types; RMC, GGA, VTG, GST, GLL, and ZDA.

Note: Constellation related messages are automatically assigned on selection of constellation type.

- *GP" indicates the GPS constellation*
- *"GL" indicates the GLONASS constellation*
- *"GN" indicates satellites for all constellations*

Delay from Fix to Start of Output:

Message output can be delayed related to time of the current fix. This establishes a known offset from the receipt of the NMEA message to the time stamp within the message; thus permitting reliable time transfer. This feature only applies to the high priority message list 3.

If the start of a NMEA out message is being used for timing purposes the "fix rate" should be set to 1 second and message list 3 used.

For >5Hz fix rate operation this parameter should be set to zero.

GLONASS satellite Format: (default ID is based on slot)

Selects satellite ID based on "frequency" or "slot" (as reported in almanac and ephemeris data).

NMEA output:

The TW5340 will output messages that are specified in up to 3 lists. Each of the message lists can be output at a different rates.

Message List 1 rate:

Sets message list 1 output rate. The rate is specified as the number of fixes between message output.

Message List 2 rate:

Sets message list 2 output rate.

There is No Message List 3 rate:

Messages from list 3 are always output at the fix rate.

NMEA Message List 1

The basic output message list is shown in Figure 12. Additional outputs are available in expert mode, contact Tallysman for details.

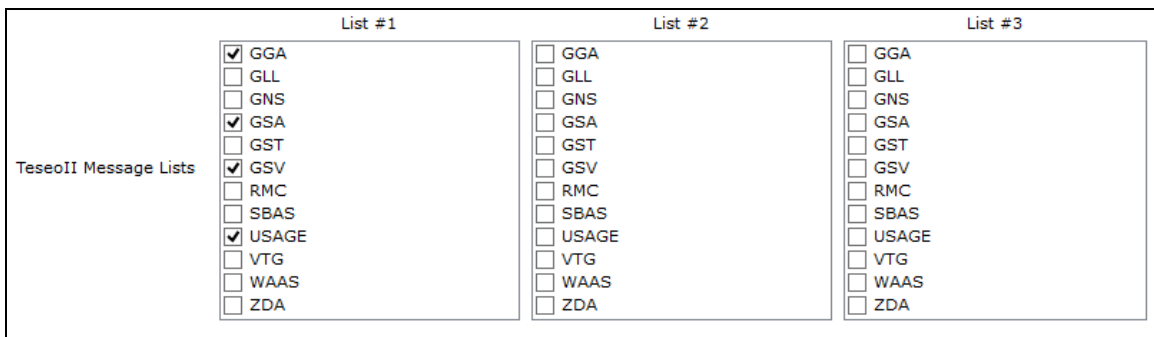

Figure 12

Message list 1 is the standard message list. Use message list 1 if the NMEA multiple output rate feature is not required.

NMEA Message List 2

Use to output messages at a different rate. For example GSV and GSA can be output at a much lower rate than RMC or GGA.

NMEA Message List 3

Message list 3 is reserved for those messages which need to be sent at a high rate (10hz) and /or require accurate message output timing (low jitter). If high rate messages or low jitter messages are not required, this message list should not be used.

If you are outputting message list 3 at 10 Hz, message list 1 & 2 should be disabled. If additional lists outputs are required the output message rate of list 1 will need to be

reduced e.g. if you configure message list 3 to output GGA at 8 Hz then message list 1 can be configure to output once per second (by setting the Message List 1 Rate to 8).

Note 1: When configuring additional NMEA lists, check that the baud rate is high enough to ensure there is enough time to output all messages.

10 Hz. Operation

For 10 Hz operation the following configuration settings are required:

[1] In the “Interface” tab: set the “NMEA Baudrate” to at least 115200.

The next time the configurator is run be sure to set the “COM Port Baudrate” in the “Program” Menu “COM Port...” tab to the same value.

[2] In the “General” tab set:

[a] “Fix Rate (sec)” option to “.1”

[b] “CPU Clock Speed” option to “208 MHz (PLL)”

[3] In the “Message” tab set:

[a] “Delay from Fix to Start of Output (ms)” option to 0

[b] Uncheck all items from List #1 and List #2 (*)

[c] Check just one item for List #3

(*) If more NMEA sentence outputs are required, then set the “Message List #1 Rate” option to 10, so the selected sentences in List #1 are output at most once per second.

[4] If fix rate is > 5Hz.

[a] In the “Tracking” tab check “High Dynamics”.

This enables a higher DSP sample rate.

11.4 CONSTELLATIONS

Enable GPS Constellation and fix

Enables GPS constellation. (Note for GNS messages the talker ID is “GP” unless GLONASS is also selected, in which case, the talker ID will be “GN”).

Enable GLONASS Constellation and Fix:

Enables GLONASS constellation. (Note for GNS messages the talker ID is “GL” unless GPS is also selected, in which case, the talker ID will be “GN”).

Enable SBAS (WAAS):

When set and if data is currently received from an SBAS satellite, then the TW5340 includes the SBAS corrections in the calculated position.

SBAS Auto-Search: (default ON)

The TW5340 will automatically search for an appropriate satellite in view.

SBAS PRN

Set the SBAS satellite number to track.

SBAS -1 Parameter: PRN

Two additional SBAS satellites can be added to the SBAS search list. Enter PRN, Longitude, and Service for each SBAS satellite.

SBAS -1 Parameter: Longitude

See Table 5 column 5

SBAS -1 Parameter: Service

See Table 5, column 1

SBAS -2 Parameter: PRN

See Table 5 column 4.

SBAS -2 Parameter: Longitude

See Table 5 column 5

SBAS -2 Parameter: Service

See Table 5 column 1

11.5 TRACKING

2 D Fix: (default off)

Enables a two-dimensional GPS position fix that includes only horizontal coordinates (no GPS elevation). It requires a minimum of three visible satellites.

Walking mode: (default off)

The receiver engine uses different filters in walking mode i.e. does not include velocity in position calculations or accelerations that are not feasible by a pedestrian, and maintain accurate position in urban environments during lower operating speeds (0.5 to 3 m/sec) such as walking or even running.

Stop Detection: (default on)

This enables “pinning” the position while stopped to minimize “wandering” such as in an automotive application at a stop light. It also has protection to prevent it from getting stuck in an undesirable mode when the user dynamics change.

This feature should be disabled when doing ‘wander’ testing or when walking mode is enabled.

High Dynamics: (default off)

The receiver engine uses different filters for high acceleration applications.

Must be enabled when the fix rate is >5Hz.

Acquisition Mask Angle (degrees):

The elevation angle of a GNSS satellite below which data will be ignored when acquiring a fix. A lower mask angle may lead to faster acquisition.

Positioning Mask Angle:

The elevation angle of a GNSS satellite below which data will be ignored once a fix has been acquired. Once a fix has been acquired the mask angle can be increased so that only high satellites are tracked. By setting this parameter to a value less than the acquisition mask angle the satellite will always be used in a fix once it is acquired.

Having larger values helps reduce multipath errors.

Tracking Threshold (SNR):

This parameter sets the minimum C/N0 threshold to track a satellite. Any GNSS satellite, with C/N0 less than the threshold value is dropped and the engine searches for another satellite with a stronger signal level. Increasing the tracking threshold decreases the GNSS sensitivity, but helps prevent errors due to multipath. The value must be in the range 10 to 40. The default is 10.

Positioning Threshold (SNR):

A satellite must have a signal strength above this threshold to be included in a fix calculation. The default is 15, which helps reduce multi-path errors.

Default 2D DOPS

A low DOP value represents a better positional precision due to the wider angular separation between the satellites used to calculate a unit's position.

These are the maximum allowable values for calculating a 2D fix.

Default 3D DOPS:

These are the maximum allowable values for calculating a 3D fix.

Startup 2D DOPS

Set these values the same as the default 2D DOPS.

Startup 3D DOP:

Set these values the same as the default 3D DOPS.

11.6 1 PPS TAB

1PPS Enable:

1PPS is output when set.

Invert 1PPS Polarity:

The polarity of the 1PPS output is inverted.

1 PPS Hold Position:

The configured Hold Position is used in Timing application as the current position.

The accuracy and integrity of the timing solution is highly dependent on the accuracy of the reference position. Position can be set and held but should be generated from a highly accurate survey grade receiver. If this is not available, the reference position may be determined automatically by position hold auto-survey command to self-survey over an extended period (at the very least, 1 hour). See # Auto survey samples below.

TRAIM Enable:

Enable/disable the TRAIM algorithm

Timing Receiver Autonomous Integrity Monitoring allows the receiver to remove satellites with timing errors in excess of a given timing threshold.

1PPS Clock (Mhz)

Set to 64 Mhz for highest accuracy

1PPS pulse Duration (ms):

Duration of 1 PPS pulse, the default configuration is 250ms.

1PPS Correction (Delay in ns):

This is a time correction to compensate for any 1PPS delays due to cable length or the RF chain.

Hold Position Latitude (degrees):

Sets the latitude for the position hold mode.

Hold Position Longitude (degrees):

Set the longitude of the position hold mode.

Hold Position Height (meters):

Set altitude for the position hold mode.

Auto-survey samples

When setting the reference 1 PPS hold position, the reference position may be determined automatically by position hold auto-survey command to self-survey over an extended period (at the very least, 1 hour). Remember to scale this value by number of fixes per second.

1PPS Elevation Mask (degrees):

Sets the elevation mask angle of 1PPS.

1PPS Satellite Threshold (snr):

Fix quality evaluation only use satellites above SNR threshold.

1PPS Fix condition:

GNSS fix condition for PPS generation.

NO FIX: PPS signal is present even in GNSS NO fix conditions.

2D FIX: the PPS is present if the GNSS is at least in 2D fix condition

3D FIX: the PPS is present only if the GNSS is in 3D fix conditions.

1PPS reference time:

Sets the 1PPS time reference.

1PPS Output:

1PPS output enabled base on selection.

1PPS Constellations:

This parameter enables the usage of mixed constellations in the 1pps timing filter. If “Use GPS...” is enabled GPS satellites are used to correct the GLONASS reference time together with GLONASS satellites. If “Use GLONASS...” is enabled, GLONASS satellites are used to correct the GPS reference time together with the GPS satellites. When constellation mask is zero (default) only GPS satellites are used to correct the GPS reference time and only GLONASS satellites are used to correct the GLONASS reference time.

11.7 STANDBY TAB

Not Currently Supported on Rev 4.2 hardware

Enable Periodic Standby:

Enables the Standby mode low current consumption feature.

Sleep Time (seconds)

Sets the sleep time in seconds.

Fix Time (seconds)

Sets the navigation wake time to acquire a fix.

In order to refresh satellite ephemeris data the receiver should be configured to transitions to full power every 30 minutes and can remain awake for up to 3 minutes.

Maximum Awake Time (Fix count)

The maximum number of attempts to get a fix before resuming standby mode.

12 NMEA Message Reference

NMEA 0183 sentences are all ASCII. Each sentence begins with a dollar sign (\$) and ends with a carriage return linefeed (<CR><LF>). Data is comma delimited. A checksum is optionally added.

The first two letters following the „\$” are the talker identifier. The next three characters (sss) are the sentence identifier, followed by a number of data fields separated by commas, followed by an optional checksum, and terminated by carriage return/line feed. The data fields are uniquely defined for each sentence type.

RMC

Recommended Minimum Navigation Information

Fields

UTC Time

Status, V=Navigation receiver warning A=Valid

Latitude

N or S

Longitude

E or W

Speed over ground, knots

Track made good, degrees true

Date, ddmmyy

Magnetic Variation, degrees

E or W

FAA mode indicator (NMEA 2.3 and later)

Checksum

A status of V means the GPS has a valid fix that is below an internal quality threshold, e.g. because the dilution of precision is too high or an elevation mask test failed.

GGA

Global Positioning System Fix Data

Time, Position and fix related data for a GPS receiver.

Field :

Universal Time Coordinated (UTC)

Latitude

Direction of latitude N or S (North or South)

Longitude

Direction of Longitude E or W (East or West)

GPS Quality Indicator,

0 - fix not available,

1 - GPS fix,

2 - Differential GPS fix (values above 2 are 2.3 features)

3 = PPS fix

4 = Real Time Kinematic

5 = Float RTK

6 = estimated (dead reckoning)

7 = Manual input mode

8 = Simulation mode

Number of satellites in view, 00 - 12

Horizontal Dilution of precision (meters)

Antenna Altitude above/below mean-sea-level (geoid) (in meters)

Units of antenna altitude, meters

Geoidal separation, the difference between the WGS-84 earth ellipsoid and mean-sea-level (geoid), "-" means mean-sea-level below ellipsoid

Units of geoidal separation, meters

Age of differential GPS data, time in seconds since last SC104 type 1 or 9 update, null field when DGPS is not used

Differential reference station ID, 0000-1023

Checksum

GSA

GPS DOP and active satellites

Field :

Selection mode: M=Manual, forced to operate in 2D or 3D, A=Automatic, 3D/2D

Mode (1 = no fix, 2 = 2D fix, 3 = 3D fix)

PRN number, 01 through 32 for GPS, 33 through 64 for SBAS, 64+ for GLONASS

ID of 1st satellite used for fix

ID of 2nd satellite used for fix

ID of 3rd satellite used for fix

ID of 4th satellite used for fix

ID of 5th satellite used for fix

ID of 6th satellite used for fix

ID of 7th satellite used for fix

ID of 8th satellite used for fix

ID of 9th satellite used for fix

ID of 10th satellite used for fix

ID of 11th satellite used for fix

ID of 12th satellite used for fix

PDOP

HDOP

VDOP

Checksum

GSV

GSV - Satellites in view

These sentences describe the sky position of a GPS satellite in view. Typically they're shipped in a group of 2 or 3.

Field:

Total number of GSV messages to be transmitted in this group

Origin number of this GSV message within current group

Total number of satellites in view (leading zeros sent)

Satellite PRN number (leading zeros sent)

Elevation in degrees (00-90) (leading zeros sent)

Azimuth in degrees to true north (000-359) (leading zeros sent)

SNR in dB (00-99) (leading zeros sent) more satellite info quadruples like 4-7 n)
checksum

Example: \$GPGSV,3,1,11,03,03,111,00,04,15,270,00,06,01,010,00,13,06,292,00*74

\$GPGSV,3,2,11,14,25,170,00,16,57,208,39,18,67,296,40,19,40,246,00*74

\$GPGSV,3,3,11,22,42,067,42,24,14,311,43,27,05,244,00,,,,*4D

Some GPS receivers may emit more than 12 quadruples (more than three GPGSV sentences), even though NMEA-0813 doesn't allow this. (The extras might be WAAS satellites, for example.) Receivers may also report quads for satellites they aren't tracking, in which case the SNR field will be null.

VTG

VTG - Track made good and Ground speed

Field :

Track Degrees

T = True relative to true North

Track Degrees

M = Magnetic

Speed Knots

N = Knots

Speed Kilometers per Hour over ground

K = Kilometers per Hour

FAA mode indicator (NMEA 2.3 and later)

Checksum

GLL

Geographic Position - Latitude/Longitude

Field :

Latitude

N or S (North or South)

Longitude

E or W (East or West)

Universal Time Coordinated (UTC)

Status A - Data Valid, V - Data Invalid

FAA mode indicator (NMEA 2.3 and later)

Checksum

GNGNS

Outputs GPS and Glonass information in the same message list

GNSS capable receivers will also output this message with the GP and/or GL talker ID when using more than one constellation for the position fix.

An example of the GNS message output from a GNSS capable receiver is:

```
$GNGNS,014035.00,4332.69262,S,17235.48549,E,RR,13,0.9,25.63,11.24,,*70<CR><LF>
```

```
$GPGNS,014035.00,,,,,8,,,,1.0,23*76<CR><LF>
```

```
$GLGNS,014035.00,,,,,5,,,,1.0,23*67<CR><LF>
```

1 = Message ID \$GNS

2 = UTC of position fix

3 = Latitude

4 = Direction of latitude, N: North, S: South

5 = Longitude

6 = Direction of longitude, E: East, W: West

7 = Mode indicator:

Variable character field with one character for each supported constellation.

First character is for GPS

Second character is for GLONASS

Subsequent characters will be added for new constellation

Each character will be one of the following:

N = No fix. Satellite system not used in position fix, or fix not valid

A = Autonomous. Satellite system used in non-differential mode in position fix

D = Differential (including all OmniSTAR services). Satellite system used in differential mode in position fix

P = Precise. Satellite system used in precision mode. Precision mode is defined as: no deliberate degradation (such as Selective Availability) and higher resolution code (P-code) is used to compute position fix

R = Real Time Kinematic. Satellite system used in RTK mode with fixed integers

F = Float RTK. Satellite system used in real time kinematic mode with floating integers

E = Estimated (dead reckoning) Mode

M = Manual Input Mode

S = Simulator Mode

8= Number of SVs in use, range 00–99

9=HDOP calculated using all the satellites (GPS, GLONASS, and any future satellites) used in computing the solution reported in each GNS sentence.

10= Orthometric height in meters (MSL reference)

11= Geoidal separation in meters - the difference between the earth ellipsoid surface and mean-sea-level (geoid) surface defined by the reference datum used in the position solution

"-" = mean-sea-level surface below ellipsoid.

12= Age of differential data - Null if talker ID is GN, additional GNS messages follow with GP and/or GL Age of differential data

TW5340 User Manual

13= Reference station ID1, range 0000-4095

- Null if talker ID is GN, additional GNS messages follow with GP and/or GL Reference station ID

14= The checksum data, always begins with *

ZDA

ZDA - Time & Date - UTC, day, month, year and local time zone

Field :

UTC time (hours, minutes, seconds, may have fractional subsecond)

Day, 01 to 31

Month, 01 to 12

Year (4 digits)

Local zone description, 00 to +- 13 hours

Local zone minutes description, apply same sign as local hours

Checksum

Example: \$GPZDA,160012.71,11,03,2004,-1,00*7D

Usage

\$PSTMCPU, 53.13,0,52*6d

Field :

% of CPU usage

Clock Source

Clock Speed

WAAS

\$PSTMSBAS,1,2,133,,,43*2C

Field:

Status (1= WAAS ON)

Acquire flag

PRN

Elevation

Azimuth

Two SBAS channels can be tracked:

\$PSTMSBASCH,0,133,,,26*76

Field:

Channel #

PRN

Elevation

Azimuth

\$PSTMSBASCH,1,0,0,,,*42

Field :

Channel #

PRN

Elevation

Azimuth

13 Loading New Firmware

To update to the latest firmware release

- 1) Select **Program/Load firmware**

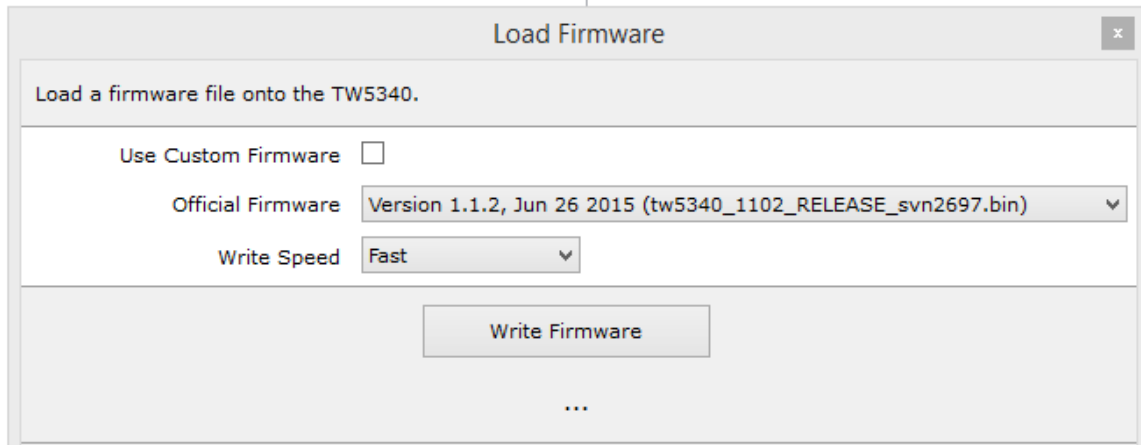

Figure 13

The latest version of the Configurator always presents you with the option to load the “official firmware” load with its associated factory default parameters.

13.1 Custom Firmware

If you wish to create your own custom firmware which includes your own specific parameters select **Program/Create custom firmware with new default configuration**

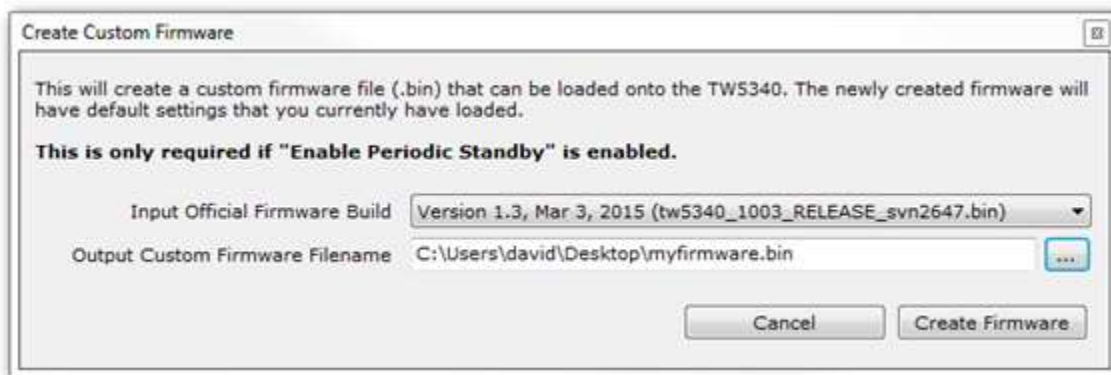

Figure 14

Select the current firmware build you are running.

Select where your custom firmware build will be output too

Select Create Firmware button.

The custom firmware will be created with the current TW5340 parameter setting you have configured.

13.2 Factory Defaults

To return the TW5340 to factory defaults configuration parameters use the following procedure:

1. Start the configurator.
2. Connect TW5340 test Adaptor (see Figure 4).
3. Power the adaptor.
4. In configurator set the COM port and READ configuration to ensure you are connected. *(This is only a connection check. Even if the device can't be read, continue with next step)*
5. Connect the Yellow wires on the test adaptor together.
6. In the Configurator select **Program/Restore factory defaults**. Cycle power to the adaptor

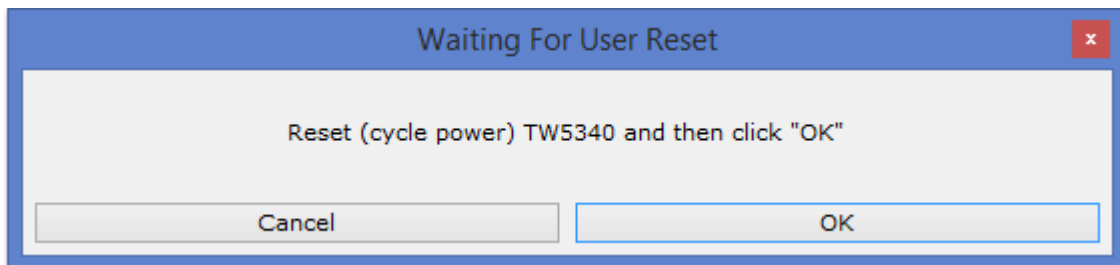
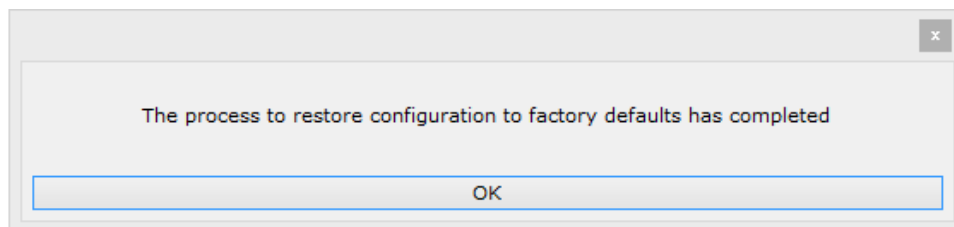

Figure 15

Click OK after cycling power.

7. Wait till done.



8. Disconnect Yellow wires and click OK.
9. Cycle the power. It may take 30 seconds before the system responds

Note: After restoring factory defaults ensure the Yellow wire cannot short by applying insulating tape to the wires.